

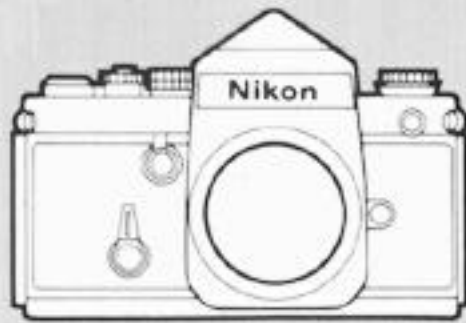

Photography in Malaysia

* Credit: Info on the F2 system supplied by : Miss Rissa , Shriro Malaysia Sdn Bhd
Distributor of Nikon cameras in Malaysia & Singapore.

The Nikon F2



The Nikon F2A Photomic

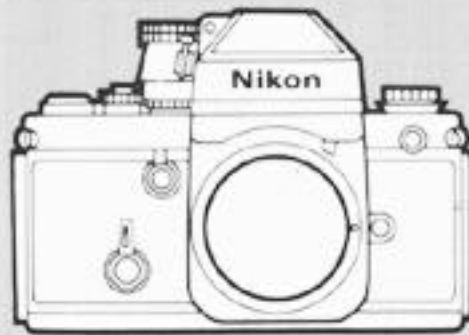

The Nikon F2AS Photomic

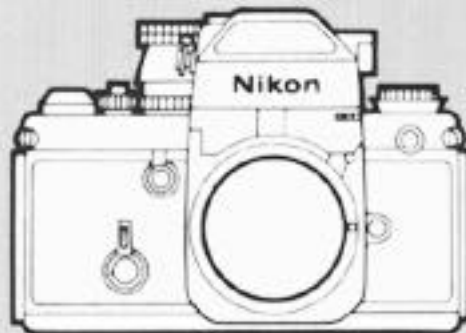

The F2 System

Nikkor Lenses

Fisheye Lenses

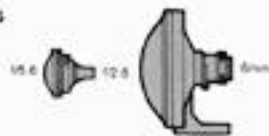

DF-1 Fisheye Finder

For 8mm 15.5 and 10mm 15.5 DP



Wideangle Lenses



Normal Lenses



Telephoto Lenses



Reflex Lenses

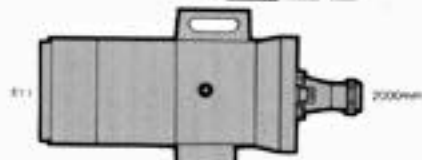
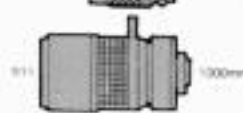

Special Lenses



Zoom Lenses



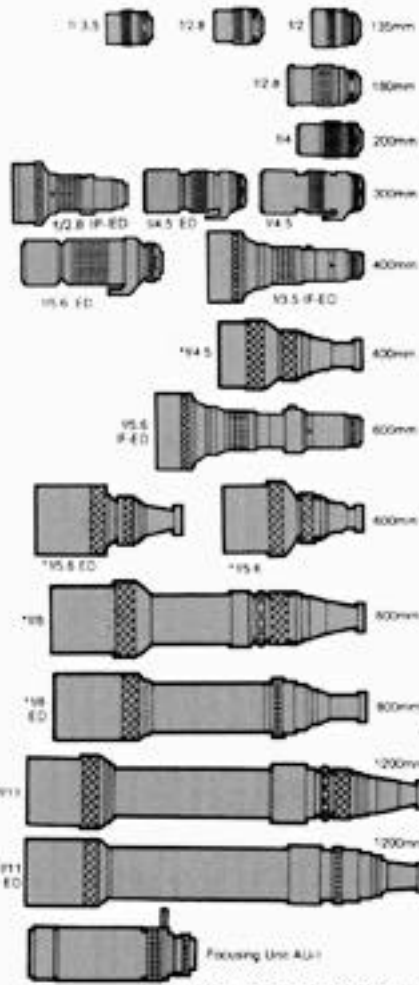

* Used with Focusing Unit AU-1

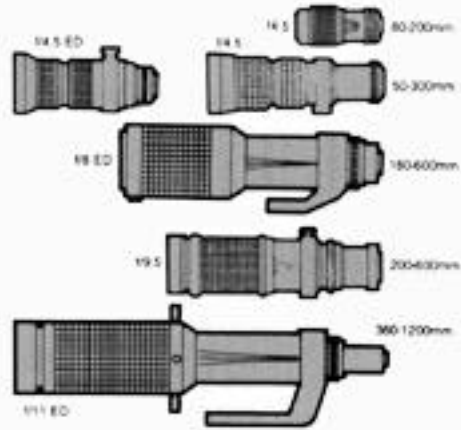

Teleconverters



Lens Accessories



1. Flexible Lens Pouch
2. Leatherette Camera-lens Case
3. Leatherette Lens Case
4. Plastic Lens Case
5. Lens Hood
6. Lens Cap
7. Rear Lens Cap
8. Filter
9. Gelatine Filter Holder

Finders & Accessories

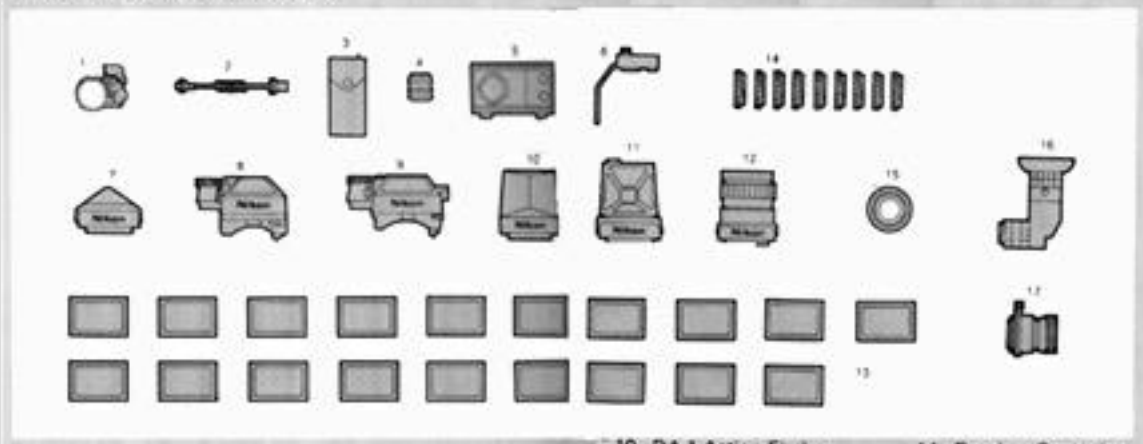

- | | | | |
|-----------------------------------------|-------------------------------|------------------------------------------------------------------------------------------------------------------------------------------------------------------------------------------------|-----------------------------------------|
| 1. DS-12 EE Aperture Control Attachment | 6. DL-1 Photomic Illuminator | 10. DA-1 Action Finder | 14. Eyepiece Correction Lenses |
| 2. DM-1 Connecting Cord | 7. DE-1 Eyelevel | 11. DW-1 Waist-level Finder | 15. Rubber Eyecup |
| 3. DB-1 Battery Pack | 8. DP-11 F2A Finder | 12. DW-2 6X Focusing Finder | 16. DR-3 Right-angle Viewing Attachment |
| 4. DN-1 NC Battery | 9. DP-12 F2AS Photomic Finder | 13. Focusing Screens (A, B, C, D, E, G ₁ , G ₂ , G ₃ , G ₄ , H ₁ , H ₂ , H ₃ , H ₄ , J, K, L, M, P, R) | 17. Eyepiece Magnifier |
| 5. DH-1 NC Battery Charger | | | |

Close-Up Equipment

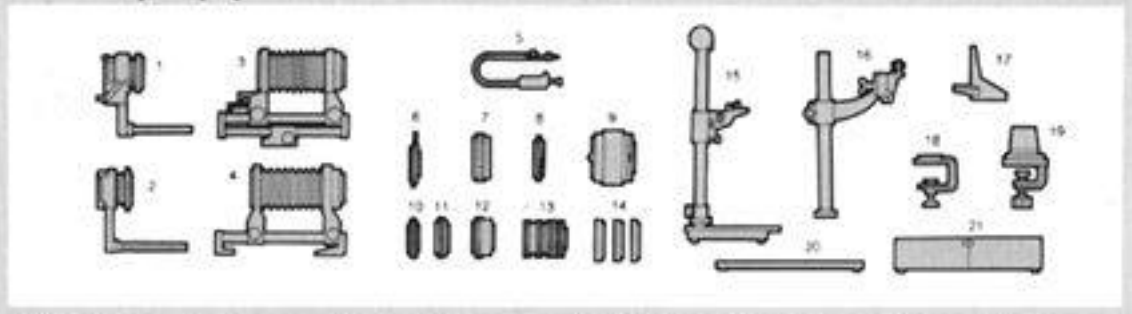

- | | | | |
|-------------------------------------|-------------------------------|--------------------------------|------------------------------------------|
| 1. PS-4 Slide Copying Adapter | 6. BR-4 Auto Ring | 12. PK-13 Auto Extension Ring | 18. PA-3 Table Clamp (for PF-2) |
| 2. PS-5 Slide Copying Adapter | 7. BR-3 Macro Ring Adapter | 13. Extension Ring Set K | 19. PC-3 Table Clamp (for PF-3) |
| 3. PB-4 Bellows Focusing Attachment | 8. BR-2 Macro Ring Adapter | 14. Close-up Attachment Lenses | 20. PA-2 Baseboard (for PF-2) |
| 4. PB-5 Bellows Focusing Attachment | 9. PN-11 Auto Extension Ring | 15. PF-3 Repro-copy Outfit | 21. PA-1 Wooden Carrying Case (for PF-2) |
| 5. AR-4 Double Cable Release | 10. PK-11 Auto Extension Ring | 16. PF-2 Repro-copy Basic Unit | |
| | 11. PK-12 Auto Extension Ring | 17. PH-3 MD Holder (for PF-3) | |

F2 Data Camera Backs & Accessories

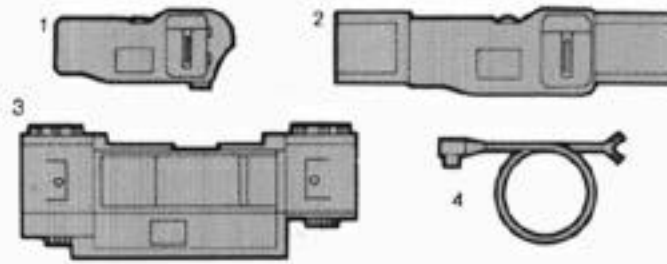

(Supplied with special F2 cameras only.)

- | | |
|-------------------------------------------|----------------------------------------------|
| 1. MF-10 36-Exposure
Data Camera Back | 3. MF-1 250 Magazine
Back for Data Camera |
| 2. MF-11 250-Exposure
Data Camera Back | 4. MC-6 Connecting Cord |

Flash Units & Accessories

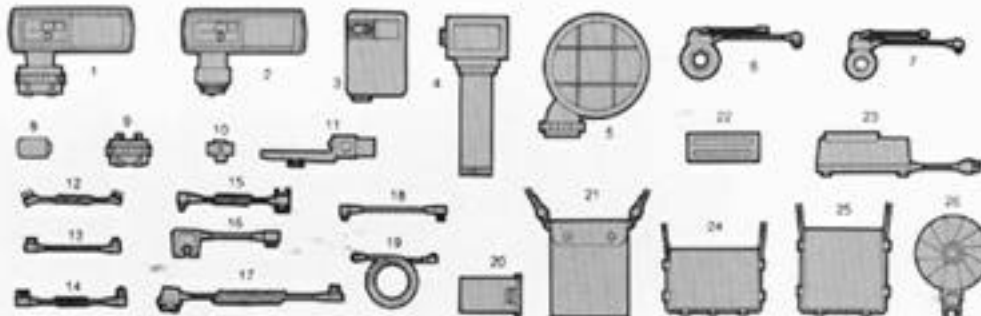

- | | | | |
|---------------------------------|----------------------------|---------------------------------------|--------------------------------------|
| 1. SB-7E Speedlight Unit | 8. SW-2 Wide-flash Adapter | 16. SC-4 Ready Light
Adapter | 21. SD-4 Battery Pack |
| 2. SB-8E Speedlight Unit | 9. AS-1 Flash Unit Coupler | 17. SC-9 Extension Cord | 22. SN-2 NC Battery Unit |
| 3. SB-9 Speedlight Unit | 10. SU-1 Sensor Unit | 18. BD-1 Sync Cord | 23. SH-2 NC Battery Quick
Charger |
| 4. SB-5 Speedlight Unit | 11. SK-3 Mounting Bracket | 19. BD-2 Sync Cord | 24. SA-3 AC Unit |
| 5. SB-6 Repeating Flash | 12. SE-2 Extension Cord | 20. Battery Holder
(for SB-7E, 8E) | 25. SD-5 DC Unit |
| 6. SR-2 Ringlight Unit | 13. SC-5 Sync Cord | | 26. BC-7 Flash Unit |
| 7. SM-2 Macro Ringlight
Unit | 14. SC-6 Coiled Sync Cord | | |
| | 15. SC-10 Sync Cord | | |

Motor Drive & Remote Control Accessories

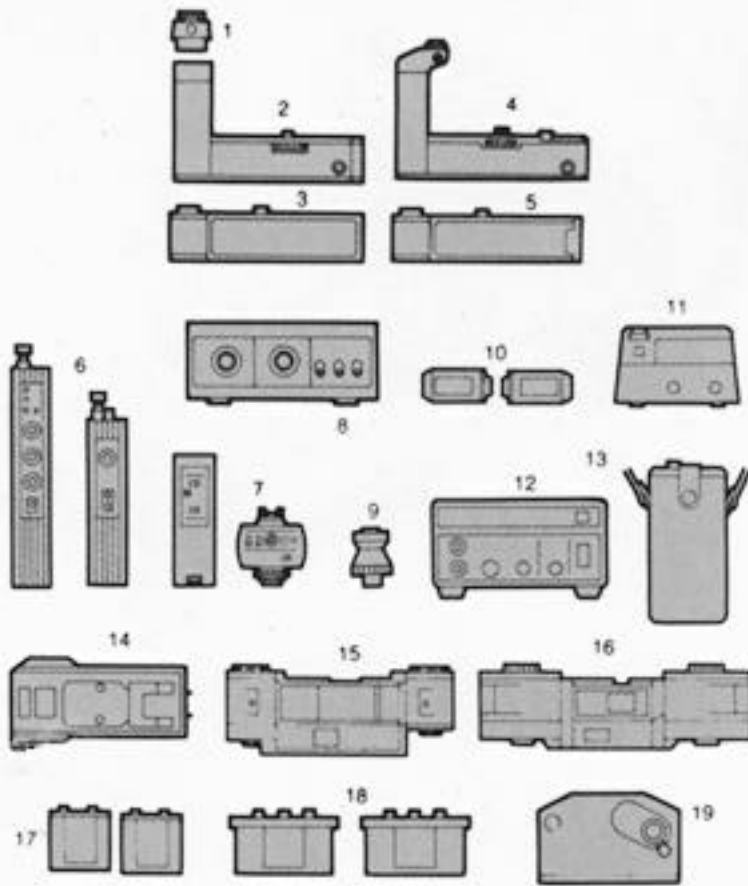

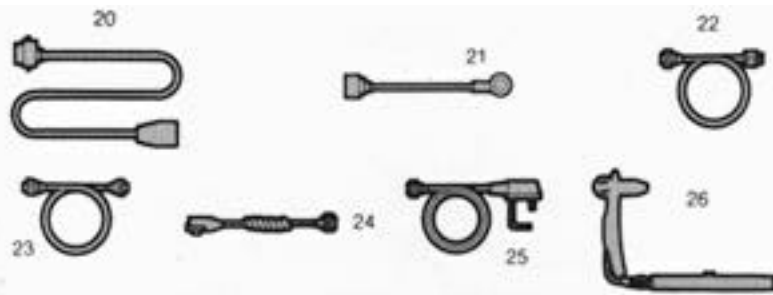

- | | |
|----------------------------------------|----------------------------------------------|
| 1. SC-2 Grip Head™
(for MD-2) | 15. MF-1 250 Magazine Back |
| 2. MD-2 Motor Drive | 16. MF-2 750 Magazine Back |
| 3. MB-1 Cordless Battery
Pack | 17. MZ-1 250-Exposure
Film Cassette |
| 4. MD-3 Motor Drive | 18. MZ-2 750-Exposure
Film Cassette |
| 5. MB-2 Cordless Battery
Pack | 19. Bulk Film Loader |
| 6. MW-1 Radio Control Set | 20. MC-1 SC Remote Cord |
| 7. ML-1 Modulite Remote
Control Set | 21. MC-8 Connecting Cord |
| 8. MT-1 Intervalometer | 22. MC-4 Remote Cord |
| 9. MR-1 Terminal Shutter | 23. MC-2 3m Connecting
Cord |
| 10. MN-1 NC Battery Unit | 24. MC-3 Grip Cord for
Pistol Grip |
| 11. MH-1 NC Battery
Charger | 25. MC-7 Connecting Cord
for Battery Pack |
| 12. MA-4 AC/DC Converter | 26. AH-1 Handstrap |
| 13. MA-3 Battery Pack Jacket | |
| 14. MF-3 Camera Back | |

Other Accessories

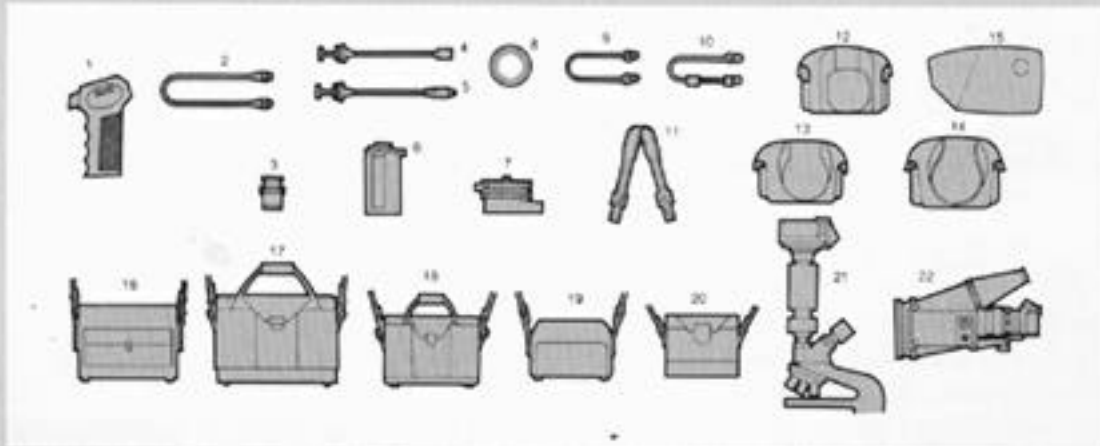

- | | | | |
|----------------------------------|----------------------------|-----------------------------|-----------------------------------------|
| 1. Pistol Grip Model 2 | 6. AM-1 Film Cassette | 15. CS-13 Blimp Camera Case | 20. FB-16 Compartment Case |
| 2. Cable Release for Pistol Grip | 7. AP-2 Panorama Head | 16. FB-8 Compartment Case | 21. Microscope Adapter Tube Model 2 |
| 3. AR-1 Soft Shutter Release | 8. Camera Body Cap | 17. FB-11A Compartment Case | 22. Oscilloscope Recording Unit Model D |
| 4. AR-2 Shutter Cable Release | 9. AN-1 Leather Neckstrap | 18. FB-15 Compartment Case | |
| 5. AR-3 Shutter Cable Release | 10. AN-3 Leather Neckstrap | 19. FB-14 Compartment Case | |
| | 11. AN-4 Nylon Neckstrap | | |
| | 12. Soft Camera Case | | |
| | 13. Semi-Soft Camera Case | | |
| | 14. Hard Camera Case | | |